

Specification for 2.13 inch EPD

Model NO. : DEPG0213BNS800F41

DKE's Confirmation:

Prepared by	Checked by	Approved by

Customer approval:

Customer	Approved by	Date

Revision History

Version	Content	Date	Producer
2.0	New release	2023/03/09	

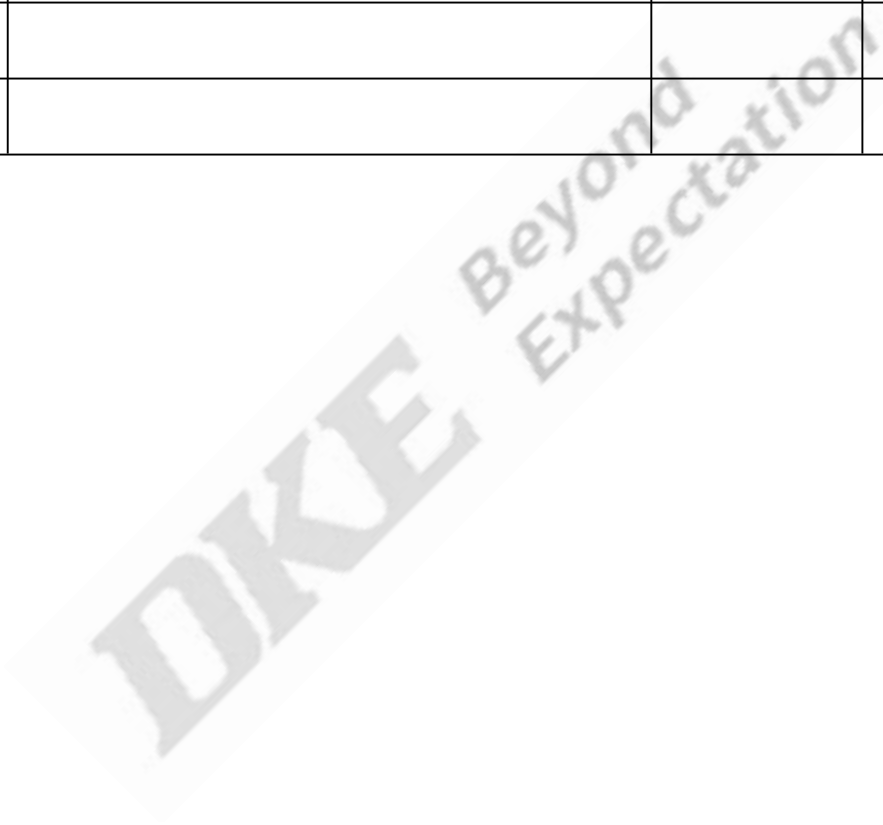

CONTENTS

1. Over View	4
2. Features	4
3. Mechanical and Optical Specification	5
4. Mechanical Drawing of EPD Module	6
5. Input/output Pin Assignment	7
6. Electrical Characteristics	8
6.1 Absolute Maximum Rating	8
6.2 Panel DC Characteristics	9
6.3 Panel DC Characteristics(Driver IC Internal Regulators)	10
6.4 Panel AC Characteristics	10
6.4.1 MCU Interface Selection	10
6.4.2 MCU Serial Interface (4-wire SPI)	10
6.4.3 MCU Serial Interface (3-wire SPI)	12
6.4.4 Interface Timing	13
7. Command Table	15
8. Block Diagram	23
9. Typical Application Circuit with SPI Interface	24
10. Typical Operating Sequence	25
10.1 OTP Operation Flow	25
10.2 OTP Operation Reference Program Code	26
11. Reliability Test	27
12. Quality Assurance	28
12.1 Environment	28
12.2 Illuminance	28
12.3 Inspect method	28
12.4 Display area	28
12.5 Ghosting test method	28
12.6 Inspection standard	29
12.6.1 Electric inspection standard	29
12.6.2 Appearance inspection standard	30
13. Packaging	32
14. Handling, Safety, and Environment Requirements	33

1. Over View

DEPG0213BNS800F41 is an Active Matrix Electrophoretic Display (AM EPD), with interface and a reference system design. The display is capable to display images at 1-bit white and black full display capabilities. The 2.13inch active area contains 122×250 pixels. The module is a TFT-array driving electrophoresis display, with integrated circuits including gate driver, source driver, MCU interface, timing controller, oscillator, DC-DC, SRAM, LUT, VCOM. Module can be used in portable electronic devices, such as Electronic Shelf Label (ESL) System.

2. Features

- ◆ 122×250 pixels display
- ◆ High contrast High reflectance
- ◆ Ultra wide viewing angle Ultra low power consumption
- ◆ Pure reflective mode
- ◆ Bi-stable display
- ◆ Commercial temperature range
- ◆ Landscape portrait modes
- ◆ Hard-coat antiglare display surface
- ◆ Ultra Low current deep sleep mode
- ◆ On chip display RAM
- ◆ Waveform can stored in On-chip OTP or written by MCU
- ◆ Serial peripheral interface available
- ◆ On-chip oscillator
- ◆ On-chip booster and regulator control for generating VCOM, Gate and Source driving voltage
- ◆ I²C signal master interface to read external temperature sensor
- ◆ Built-in temperature sensor

3.Mechanical and Optical Specification

Parameter	Specifications	Unit	Remark
Screen Size	2.13	Inch	
Display Resolution	122(H)×250(V)	Pixel	DPI:131
Active Area	23.70×48.55	mm	
Pixel Pitch	0.1942×0.1942	mm	
Pixel Configuration	Square		
Outline Dimension	29.2(H)×59.2 (V) ×1.0(D)	mm	
Weight	8.29 ± 0.3	g	

Symbol	Parameter	Conditions	Min	Typ.	Max	Units	Notes
KS	Black State L* value		-	18	20		3-1
	Black Ghosting ΔL		-	1	-		3-1
WS	White State L* value		66	67	-		3-1
	White Ghosting ΔL		-	1	-		3-1
R	White Reflectivity	White	30	34	-	%	3-1
CR	Contrast Ratio	Indoor	15:1	20:1	-		3-1
							3-2
GN	2Grey Level	-	-	-			
Life		Temp:23 ± 3°C Humidity:55 ± 10%RH		5years			3-3

Notes: 3-1. Luminance meter: Eye-One Pro Spectrophotometer.

3-2. CR=Surface Reflectance with all white pixel/Surface Reflectance with all black pixels.

3-3. When the product is stored. The display screen should be kept white and face up.

4.Mechanical Drawing of EPD Module

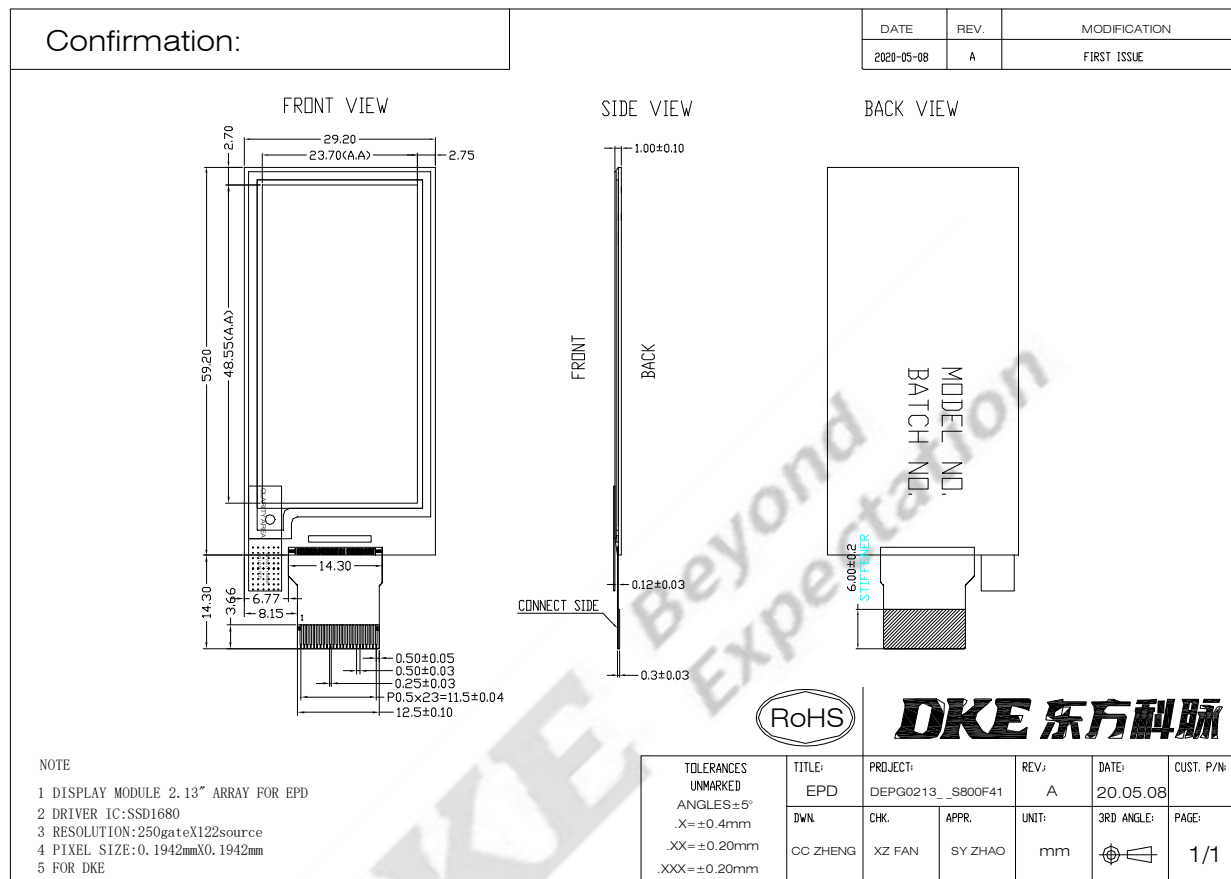

5. Input/output Pin Assignment

No.	Name	I/O	Description	Remark
1	NC		Do not connect with other NC pins	Keep Open
2	GDR	O	N-Channel MOSFET Gate Drive Control	
3	RESE	I	Current Sense Input for the Control Loop	
4	NC	NC	Do not connect with other NC pins	Keep Open
5	VSH2	C	Positive Source driving voltage 2	
6	TSCL	O	I2C Interface to digital temperature sensor Clock pin	Note 5-6
7	TSDA	I/O	I2C Interface to digital temperature sensor Data pin	Note 5-6
8	BS1	I	Bus Interface selection pin	Note 5-5
9	BUSY	O	Busy state output pin	Note 5-4
10	RES#	I	Reset signal input. Active Low.	Note 5-3
11	D/C#	I	Data /Command control pin	Note 5-2
12	CS#	I	Chip select input pin	Note 5-1
13	SCL	I	Serial Clock pin (SPI)	
14	SDA	I/O	Serial Data pin (SPI)	
15	VDDIO	P	Power Supply for interface logic pins It should be connected with VCI	
16	VCI	P	Power Supply for the chip	
17	VSS	P	Ground	
18	VDD	C	Core logic power pin VDD can be regulated internally from VCI. A capacitor should be connected between VDD and VSS	
19	VPP	P	FOR TEST	Keep Open
20	VSH1	C	Positive Source driving voltage	
21	VGH	C	Power Supply pin for Positive Gate driving voltage and VSH1	
22	VSL	C	Negative Source driving voltage	
23	VGL	C	Power Supply pin for Negative Gate driving voltage VCOM and VSL	
24	VCOM	C	VCOM driving voltage	

I = Input Pin, O =Output Pin, I/O = Bi-directional Pin (Input/output), P = Power Pin, C = Capacitor Pin

Note 5-1: This pin (CS#) is the chip select input connecting to the MCU. The chip is enabled for MCU communication only when CS# is pulled LOW.

Note 5-2: This pin is (D/C#) Data/Command control pin connecting to the MCU in 4-wire SPI mode. When the pin is pulled HIGH, the data at SDA will be interpreted as data. When the pin is pulled LOW, the data at SDA will be interpreted as command.

Note 5-3: This pin (RES#) is reset signal input. The Reset is active low.

Note 5-4: This pin is Busy state output pin. When Busy is High, the operation of chip should not be interrupted, command should not be sent. The chip would put Busy pin High when -Outputting display waveform -Communicating with digital temperature sensor

Note 5-5: Bus interface selection pin

Note 5-6: This pin connect to the VSS if there is no external temperature sensor.

BS1 State	MCU Interface
L	4-lines serial peripheral interface(SPI) - 8 bits SPI
H	3- lines serial peripheral interface(SPI) - 9 bits SPI

6. Electrical Characteristics

6.1 Absolute Maximum Rating

Parameter	Symbol	Rating	Unit
Logic supply voltage	VCI	-0.5 to +6.0	V
Logic Input voltage	VIN	-0.5 to VCI +0.5	V
Logic Output voltage	VOU	-0.5 to VCI +0.5	V
Operating Temp range	TOPR	0 to +50	°C.
Storage Temp range	TSTG	-25 to+70	°C.
Optimal Storage Temp	TSTGo	23±3	°C.
Optimal Storage Humidity	HSTGo	55±10	RH

Note: Maximum ratings are those values beyond which damages to the device may occur. Functional operation should be restricted to the limits in the Panel DC Characteristics tables.

6.2 Panel DC Characteristics

The following specifications apply for: VSS=0V, VCI=3.0V, TOPR = 25°C.

Parameter	Symbol	Condition	Applicable pin	Min.	Typ.	Max.	Unit
Single ground	V _{SS}	-		-	0	-	V
Logic supply voltage	V _{CI}	-	V _{CI}	2.2	3.0	3.7	V
Core logic voltage	V _{DD}		V _{DD}	1.7	1.8	1.9	V
High level input voltage	V _{IH}	-	-	0.8 V _{CI}	-	-	V
Low level input voltage	V _{IL}	-	-	-	-	0.2 V _{CI}	V
High level output voltage	V _{OH}	I _{OH} = -100uA	-	0.9 V _{CI}	-	-	V
Low level output voltage	V _{OL}	I _{OL} = 100uA	-	-	-	0.1 V _{CI}	V
Typical power	P _{TYP}	V _{CI} = 3.0V	-	-	10.5	-	mW
Deep sleep mode	P _{STPY}	V _{CI} = 3.0V	-	-	0.003	-	mW
Typical operating current	I _{opr_VCI}	V _{CI} = 3.0V	-	-	3.5	-	mA
Image update time	-	25 °C	-	-	4	-	sec
Typical peak current	I _{opr_VCI}	2.2~3.7v	-	-	40	50	mA
Sleep mode current	I _{slp_VCI}	DC/DC off No clock No input load Ram data retain	-	-	20	-	uA
Deep sleep mode current	I _{dslp_VCI}	DC/DC off No clock No input load Ram data not retain	-	-	1	5	uA

Notes: 1. The typical power is measured with following transition from horizontal 2 scale pattern to vertical 2 scale pattern.

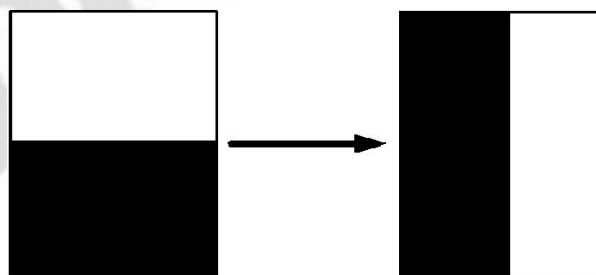

2. The deep sleep power is the consumed power when the panel controller is in deep sleep mode.

3. The listed electrical characteristics are only guaranteed under the controller & waveform provided by DKE.

4. Electrical measurement: Tektronix oscilloscope - MDO3024,

Tektronix current probe - TCP0030A.

6.3 Panel DC Characteristics(Driver IC Internal Regulators)

The following specifications apply for: VSS=0V, VCI=3.0V, TOPR =25°C.

Parameter	Symbol	Condition	Applicable pin	Min.	Typ.	Max.	Unit
VCOM output voltage	VCOM	-	VCOM	-	TBD	-	V
Positive Source output voltage	V _{SH}	-	S ₀ ~S ₁₂₁	+14.5	+15	+15.5	V
Negative Source output voltage	V _{SL}	-	S ₀ ~S ₁₂₁	-15.5	-15	-14.5	V
Positive gate output voltage	V _{gh}	-	G ₀ ~G ₂₄₉	+19	+20	+21	V
Negative gate output voltage	V _{gl}	-	G ₀ ~G ₂₄₉	-21	-20	-19	V

Notes:VGH,VGL,VSH,VSL drop voltage<2V.

6.4 Panel AC Characteristics

6.4.1 MCU Interface Selection

The pin assignment at different interface mode is summarized in Table 6-4-1. Different MCU mode can be set by hardware selection on BS1 pins. The display panel only supports 4-wire SPI or 3-wire SPI interface mode.

Pin Name	Data/Command Interface		Control Signal		
Bus interface	SDA	SCL	CS#	D/C#	RES#
BS1=L 4-wire SPI	SDA	SCL	CS#	D/C#	RES#
BS1=H 3-wire SPI	SDA	SCL	CS#	L	RES#

6.4.2 MCU Serial Interface (4-wire SPI)

The serial interface consists of serial clock SCL, serial data SDA, D/C#, CS#. This interface supports Write mode and Read mode.

Function	CS#	D/C#	SCL
Write command	L	L	↑
Write data	L	H	↑

Note: ↑ stands for rising edge of signal

In the write mode SDA is shifted into an 8-bit shift register on every rising edge of SCL in the order of D7, D6, ... D0. The level of D/C# should be kept over the whole byte . The data byte in the shift register is written to the Graphic Display Data RAM /Data Byte register or command Byte register according to D/C# pin.

Figure 6-1: Write procedure in 4-wire SPI mode

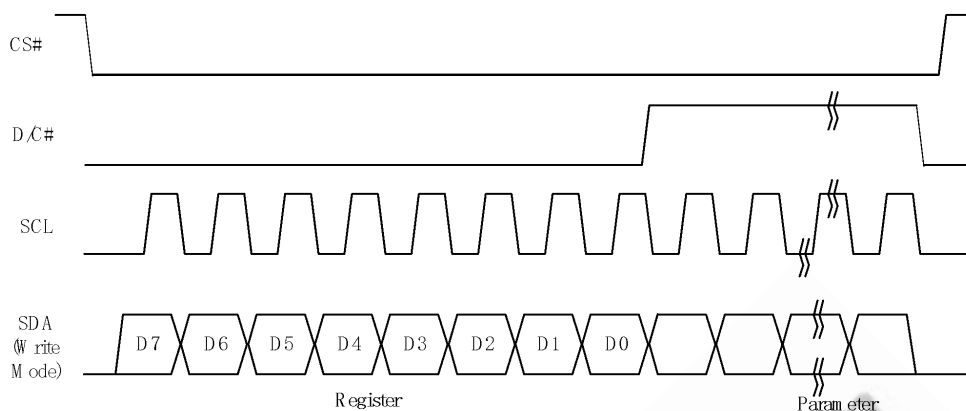

In the Read mode:

1. After driving CS# to low, MCU need to define the register to be read.
2. SDA is shifted into an 8-bit shift register on every rising edge of SCL in the order of D7, D6, ... D0 with D/C# keep low.
3. After SCL change to low for the last bit of register, D/C# need to drive to high.
4. SDA is shifted out an 8-bit data on every falling edge of SCL in the order of D7, D6, ... D0.
5. Depending on register type, more than 1 byte can be read out. After all byte are read, CS# need to drive to high to stop the read operation.

Figure 6-2: Read procedure in 4-wire SPI mode

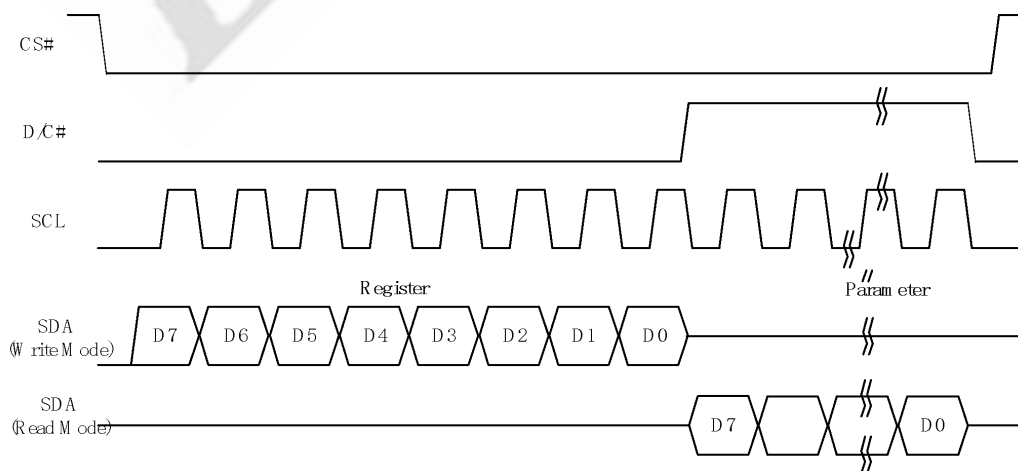

6.4.3 MCU Serial Interface (3-wire SPI)

The 3-wire serial interface consists of serial clock SCL, serial data SDA and CS#. This interface also supports Write mode and Read mode.

The operation is similar to 4-wire serial interface while D/C# pin is not used. There are altogether 9-bits will be shifted into the shift register on every ninth clock in sequence: D/C# bit, D7 to D0 bit. The D/C# bit (first bit of the sequential data) will determine the following data byte in the shift register is written to the Display Data RAM (D/C# bit = 1) or the command register (D/C# bit = 0).

Function	CS#	D/C#	SCL
Write command	L	Tie	↑
Write data	L	Tie	↑

Note: ↑ stands for rising edge of signal

Figure 6-3: Write procedure in 3-wire SPI mode

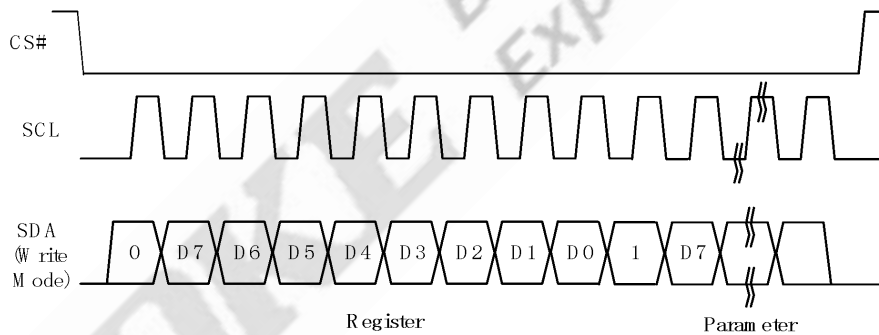

In the Read mode:

1. After driving CS# to low, MCU need to define the register to be read.
2. D/C=0 is shifted thru SDA with one rising edge of SCL
3. SDA is shifted into an 8-bit shift register on every rising edge of SCL in the order of D7, D6, ... D0.
4. D/C=1 is shifted thru SDA with one rising edge of SCL
5. SDA is shifted out an 8-bit data on every falling edge of SCL in the order of D7, D6, ... D0.
6. Depending on register type, more than 1 byte can be read out. After all byte are read, CS# need to drive to high to stop the read operation.

Figure 6-4: Read procedure in 3-wire SPI mode

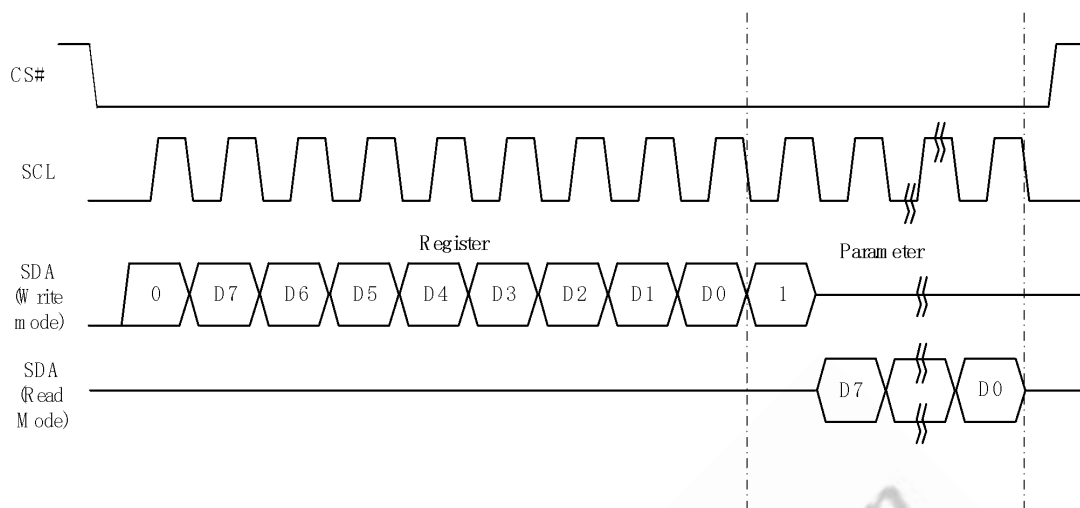

6.4.4 Interface Timing

The following specifications apply for: VSS=0V, VCI=3.0V, T_{OPR} =25°C.

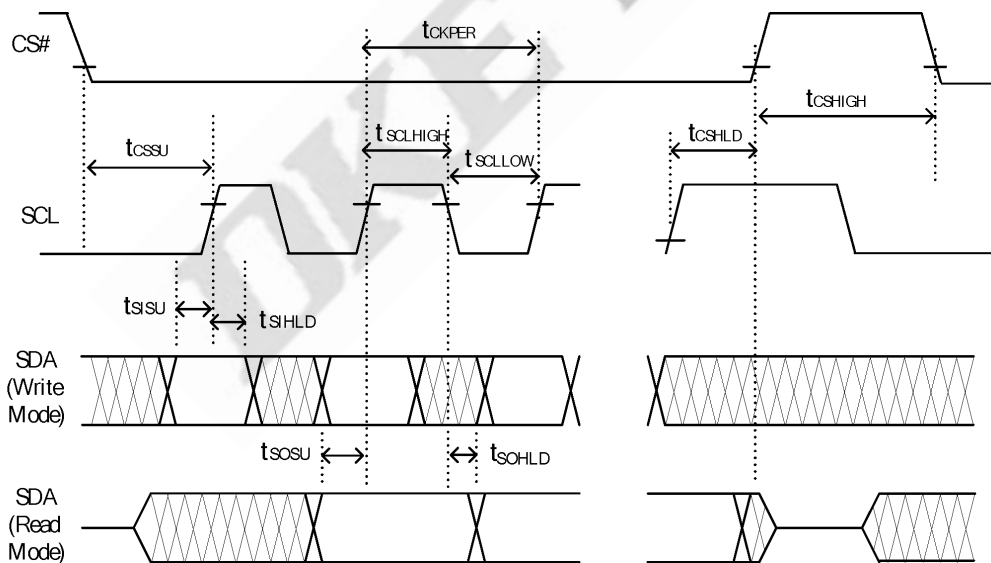

Changed Diagram

Serial Interface Timing Characteristics

(VCI - VSS = 2.2V to 3.7V, TOPR = 25°C, CL=20pF)

Write mode

Symbol	Parameter	Min	Typ.	Max	Unit
fSCL	SCL frequency (Write Mode)			20	MHz
tCSSU	Time CS# has to be low before the first rising edge of SCLK	60			ns
tCSHLD	Time CS# has to remain low after the last falling edge of SCLK	65			ns
tCSHIGH	Time CS# has to remain high between two transfers	100			ns
tSCLHIGH	Part of the clock period where SCL has to remain high	25			ns
tSCLLOW	Part of the clock period where SCL has to remain low	25			ns
tSISU	Time SI (SDA Write Mode) has to be stable before the next rising edge of SCL	10			ns
tSIHLD	Time SI (SDA Write Mode) has to remain stable after the rising edge of SCL	40			ns

Read mode

Symbol	Parameter	Min	Typ.	Max	Unit
fSCL	SCL frequency (Read Mode)			2.5	MHz
tCSSU	Time CS# has to be low before the first rising edge of SCLK	100			ns
tCSHLD	Time CS# has to remain low after the last falling edge of SCLK	50			ns
tCSHIGH	Time CS# has to remain high between two transfers	250			ns
tSCLHIGH	Part of the clock period where SCL has to remain high	180			ns
tSCLLOW	Part of the clock period where SCL has to remain low	180			ns
tSOSU	Time SO(SDA Read Mode) will be stable before the next rising edge of SCL		50		ns
tSOHLD	Time SO (SDA Read Mode) will remain stable after the falling edge of SCL		0		ns

7.Command Table

R/W#	D/C#	Hex	D7	D6	D5	D4	D3	D2	D1	D0	Command	Description
0	0	01	0	0	0	0	0	0	0	1	Driver Output control	Gate setting Set A[8:0]=00F9h Set B[8:0]=00h
0	1		A7	A6	A5	A4	A3	A2	A1	A0		
0	1		0	0	0	0	0	0	0	A8		
0	1		0	0	0	0	0	B2	B1	B0		
0	0	03	0	0	0	0	0	0	1	1	Gate Driving voltage control	SetGate Driving voltage A[4:0]=17h[POR],VGH at 20V[POR] VGH setting from 10V to 20V
0	1		0	0	0	A4	A3	A2	A1	A0		
0	0	04	0	0	0	0	0	1	0	0	Source Driving voltage control	Set Source Driving voltage A[7:0]= 41h[POR],VSH1 at 15V B[7:0]=A Ch[POR],VSH2 at 5.4V C[7:0]= 32h[POR], VSL at -15V
0	1		A7	A6	A5	A4	A3	A2	A1	A0		
0	1		B7	B6	B5	B4	B3	B2	B1	B0		
0	1		C7	C6	C5	C4	C3	C2	C1	C0		
0	0	08	0	0	0	0	1	0	0	0	Initial Code Setting OTP Program	Program Initial Code Setting The command required CLKEN=1. Refer to Register 0x22 for detail. BUSY pad will output high during operation
0	0	09	0	0	0	0	1	0	0	1	Write Register for Initial Code Setting	Write Register for Initial Code Setting Selection A[7:0] ~ D[7:0]: Reserved Details refer to Application Notes of Initial Code Setting
0	1		A7	A6	A5	A4	A3	A2	A1	A0		
0	1		B7	B6	B5	B4	B3	B2	B1	B0		
0	1		C7	C6	C5	C4	C3	C2	C1	C0		
0	1		D7	D6	D5	D4	D3	D2	D1	D0		
0	0	0A	0	0	0	0	1	0	1	0	Read Register for Initial Code Setting	Read Register for Initial Code Setting
0	0	10	0	0	0	1	0	0	0	0	Deep Sleep mode	Deep Sleep mode Control: A[1:0] : Description 00 Normal Mode [POR] 01 Enter Deep Sleep Mode 1 11 Enter Deep Sleep Mode 2 After this command initiated, the chip will enter Deep Sleep Mode, BUSY pad will keep output high. Remark: To Exit Deep Sleep mode, User required to send HWRESET to the driver
0	1		0	0	0	0	0	0	0	A0		

0	0	11	0	0	0	1	0	0	0	1	Data Entry mode setting	<p>Define data entry sequence A[2:0] = 011 [POR] A [1:0] = ID[1:0] Address automatic increment / decrement setting The setting of incrementing or decrementing of the address counter can be made independently in each upper and lower bit of the address. 00 - Y decrement, X decrement, 01 - Y decrement, X increment, 10 - Y increment, X decrement, 11 - Y increment, X increment [POR] A[2] = AM Set the direction in which the address counter is updated automatically after data are written to the RAM. AM= 0, the address counter is updated in the X direction. [POR] AM = 1, the address counter is updated in the Y direction</p>
0	1		0	0	0	0	0	A ₂	A ₁	A ₀		

0	0	0C	0	0	0	0	1	1	0	0	Booster Soft start Control	<p>Booster Enable with Phase 1, Phase 2 and Phase 3 for soft start current and duration setting.</p> <p>A[7:0] -> Soft start setting for Phase1 = 8Bh [POR]</p> <p>B[7:0] -> Soft start setting for Phase2 = 9Ch [POR]</p> <p>C[7:0] -> Soft start setting for Phase3 = 96h [POR]</p> <p>D[7:0] -> Duration setting = 0Fh [POR]</p> <p>Bit Description of each byte: A[6:0] / B[6:0] / C[6:0]: Bit[6:4] Driving Strength Selection</p> <p>000 1(Weakest) 001 2 010 3 011 4 100 5 101 6 110 7 111 8(Strongest)</p> <p>Bit[3:0] Min Off Time Setting of GDR [Time unit] 0000 ~ 0011 NA 0100 2.6 0101 3.2 0110 3.9 0111 4.6 1000 5.4 1001 6.3 1010 7.3 1011 8.4 1100 9.8 1101 11.5 1110 13.8 1111 16.5</p> <p>D[5:0]: duration setting of phase D[5:4]: duration setting of phase 3 D[3:2]: duration setting of phase 2 D[1:0]: duration setting of phase 1 Bit[1:0] Duration of Phase [Approximation] 00 10ms 01 20ms 10 30ms 11 40ms</p>
0	1		1	A6	A5	A4	A3	A2	A1	A0		
0	1		1	B6	B5	B4	B3	B2	B1	B0		
0	1		1	C6	C5	C4	C3	C2	C1	C0		
0	1		0	0	D5	D4	D3	D2	D1	D0		

0	0	12	0	0	0	1	0	0	1	0	SWRESET	It resets the commands and parameters to their S/W Reset default values except R10h-Deep Sleep Mode During operation, BUSY pad will output high. Note: RAM are unaffected by this command.
0	0	18	0	0	0	1	1	0	0	0	Temperature Sensor Control	Temperature Sensor Selection A[7:0] = 48h [POR], external temperature sensor A[7:0] = 80h Internal temperature sensor
0	1		A7	A6	A5	A4	A3	A2	A1	A0		
0	0	1A	0	0	0	1	1	0	1	0	Temperature Sensor Control (Write to temperature register)	Write to temperature register. A[11:0] = 7FFh [POR]
0	1		A7	A6	A5	A4	A3	A2	A1	A0		
0	1		B7	B6	B5	B4	0	0	0	0		
0	0	20	0	0	1	0	0	0	0	0	Master Activation	Activate Display Update Sequence The Display Update Sequence Option is located at R22h User should not interrupt this operation to avoid corruption of panel images.
0	0	21	0	0	1	0	0	0	0	1	Display Update Control 1	RAM content option for Display Update A[7:0] = 00h [POR] B[7:0] = 00h [POR] A[7:4] Red RAM option 0000 Normal 0100 Bypass RAM content as 0 1000 Inverse RAM content A[3:0] BW RAM option 0000 Normal 0100 Bypass RAM content as 0 1000 Inverse RAM content B[7] Source Output Mode 0 Available Source from S0 to S175 1 Available Source from S8 to S167
0	1		A7	A6	A5	A4	A3	A2	A1	A0		
0	1		B7	0	0	0	0	0	0	0		

0	0	22	0	0	1	0	0	0	1	0	Display Update Control 2	<p>Display Update Sequence Option: Enable the stage for Master Activation A[7:0]= FFh (POR) Operating sequence Parameter (in Hex) Enable clock signal 80 Disable clock signal 01 Enable clock signal Enable Analog C0 Disable Analog Disable clock signal 03 Enable clock signal Load LUT with DISPLAY Mode 1 Disable clock signal 91 Enable clock signal Load LUT with DISPLAY Mode 2 Disable clock signal 99 Enable clock signal Load temperature value Load LUT with DISPLAY Mode 1 Disable clock signal B1 Enable clock signal Load temperature value Load LUT with DISPLAY Mode 2 Disable clock signal B9 Enable clock signal Enable Analog Display with DISPLAY Mode 1 Disable Analog Disable OSC C7 Enable clock signal Enable Analog Display with DISPLAY Mode 2 Disable Analog Disable OSC CF Enable clock signal Enable Analog Load temperature value DISPLAY with DISPLAY Mode 1 Disable Analog Disable OSC F7 Enable clock signal Enable Analog Load temperature value DISPLAY with DISPLAY Mode 2</p>
0	1		A7	A6	A5	A4	A3	A2	A1	A0		

0	0	24	0	0	1	0	0	1	0	0	Write RAM (Black White) / RAM 0x24	After this command, data entries will be written into the BW RAM until another command is written. Address pointers will advance accordingly For Write pixel: Content of Write RAM(BW) = 1 For Black pixel: Content of Write RAM(BW) = 0
0	0	26	0	0	1	0	0	1	1	0	Write RAM (RED) / RAM 0x26)	After this command, data entries will be written into the RED RAM until another command is written. Address pointers will advance accordingly. For Red pixel: Content of Write RAM(RED) = 1 For non-Red pixel [Black or White]: Content of Write RAM(RED) = 0
0	0	2C	0	0	1	0	1	1	0	0	Write VCOM register	Write VCOM register from MCU interface A[7:0] = 00h [POR]
0	1		A7	A6	A5	A4	A3	A2	A1	A0		
0	0	2D	0	0	1	0	1	1	0	1	OTP Register Read for Display Option	Read Register for Display Option: A[7:0]: VCOM OTP Selection (Command 0x37, Byte A) B[7:0]: VCOM Register (Command 0x2C) C[7:0]~G[7:0]: Display Mode (Command 0x37, Byte B to Byte F) [5 bytes] H[7:0]~K[7:0]: Waveform Version (Command 0x37, Byte G to Byte J) [4 bytes]
1	1		A7	A6	A5	A4	A3	A2	A1	A0		
1	1		B7	B6	B5	B4	B3	B2	B1	B0		
1	1		C7	C6	C5	C4	C3	C2	C1	C0		
1	1		D7	D6	D5	D4	D3	D2	D1	D0		
1	1		E7	E6	E5	E4	E3	E2	E1	E0		
1	1		F7	F6	F5	F4	F3	F2	F1	F0		
1	1		G7	G6	G5	G4	G3	G2	G1	G0		
1	1		H7	H6	H5	H4	H3	H2	H1	H0		
1	1		I7	I6	I5	I4	I3	I2	I1	I0		
1	1		J7	J6	J5	J4	J3	J2	J1	J0		
1	1		K7	K6	K5	K4	K3	K2	K1	K0		
0	0	2F	0	0	1	0	1	1	1	1	Status Bit Read	Read IC status Bit [POR 0x01] A[5]: HV Ready Detection flag [POR=0] 0: Ready 1: Not Ready A[4]: VCI Detection flag [POR=0] 0: Normal 1: VCI lower than the Detect level A[3]: [POR=0] A[2]: Busy flag [POR=0] 0: Normal 1: BUSY A[1:0]: Chip ID [POR=01] Remark: A[5] and A[4] status are not valid after RESET, they need to be initiated by command 0x14 and command 0x15 respectively

0	0	30	0	0	1	1	0	0	0	0	Program WS OTP	Program OTP of Waveform Setting The contents should be written into RAM before sending this command. The command required CLKEN=1. Refer to Register 0x22 for detail. BUSY pad will output high during operation
0	0	32	0	0	1	1	0	0	1	0	Write LUT register	Write LUT register from MCU interface [153 bytes], which contains the content of VS[nX-LUTm], TP[nX], RP[n], SR[nXY], FR[n] and XON[nXY] Refer to Session 6.7 WAVEFORM SETTING
0	1		A7	A6	A5	A4	A3	A2	A1	A0		
0	1		B7	B6	B5	B4	B3	B2	B1	B0		
0	1		:	:	:	:	:	:	:	:		
0	1		:	:	:	:	:	:	:	:		
0	1		:	:	:	:	:	:	:	:		
0	1		:	:	:	:	:	:	:	:		
0	0	39	0	0	1	1	1	0	0	1	OTP program mode	OTP program mode A[1:0] = 00: Normal Mode [POR] A[1:0] = 11: Internal generated OTP programming voltage Remark: User is required to EXACTLY follow the reference code sequences

0	0	3C	0	0	1	1	1	1	0	0			Select border waveform for VBD A[7:0] = C0h [POR], set VBD as HiZ. A [7:6] :Select VBD option A[7:6] Select VBD as 00 GS Transition, Defined in A[2] and A[1:0] 01 Fix Level, Defined in A[5:4] 10 VCOM 11[POR] HiZ A [5:4] Fix Level Setting for VBD A[5:4] VBD level 00 VSS 01 VSH1 10 VSL 11 VSH2
0	1		A ₇	A ₆	A ₅	A ₄	0	0	A ₁	A ₀			A[2] GS Transition control A[2] GS Transition control 0 Follow LUT (Output VCOM @ RED) 1 Follow LUT A [1:0] GS Transition setting for VBD A[1:0] VBD Transition 00 LUT0 01 LUT1 10 LUT2 11 LUT3
0	0	44	0	1	0	0	0	1	0	0	Set RAM X - address Start / End position	Specify the start/end positions of the window address in the X direction by an address unit A[4:0]: XSA[4:0], X Start, POR = 01h B[4:0]: XEA[4:0], X End, POR = 10h	
0	1		0	0	0	A ₄	A ₃	A ₂	A ₁	A ₀			
0	1		0	0	0	B ₄	B ₃	B ₂	B ₁	B ₀	Set Ram Y- address Start / End position	Specify the start/end positions of the window address in the Y direction by an address unit A[8:0]: YSA[8:0], Y Start, POR = 00F9h B[8:0]: YEA[8:0], Y End, POR = 0000h	
0	1		B ₇	B ₆	B ₅	B ₄	B ₃	B ₂	B ₁	B ₀			
0	1		0	0	0	0	0	0	0	B ₈	Set RAM X address counter	Make initial settings for the RAM X address in the address counter (AC) A[4:0]: XAD[4:0], POR is 01h	
0	0	4E	0	1	0	0	1	1	1	0			
0	1		0	0	0	A ₄	A ₃	A ₂	A ₁	A ₀	Set RAM Y address counter	Make initial settings for the RAM Y address in the address counter (AC) A[8:0]: YAD[8:0], POR is 00F9h	
0	0	4F	0	1	0	0	1	1	1	1			
0	1		A ₇	A ₆	A ₅	A ₄	A ₃	A ₂	A ₁	A ₀			
0	1		0	0	0	0	0	0	0	A ₈			

8. Block Diagram

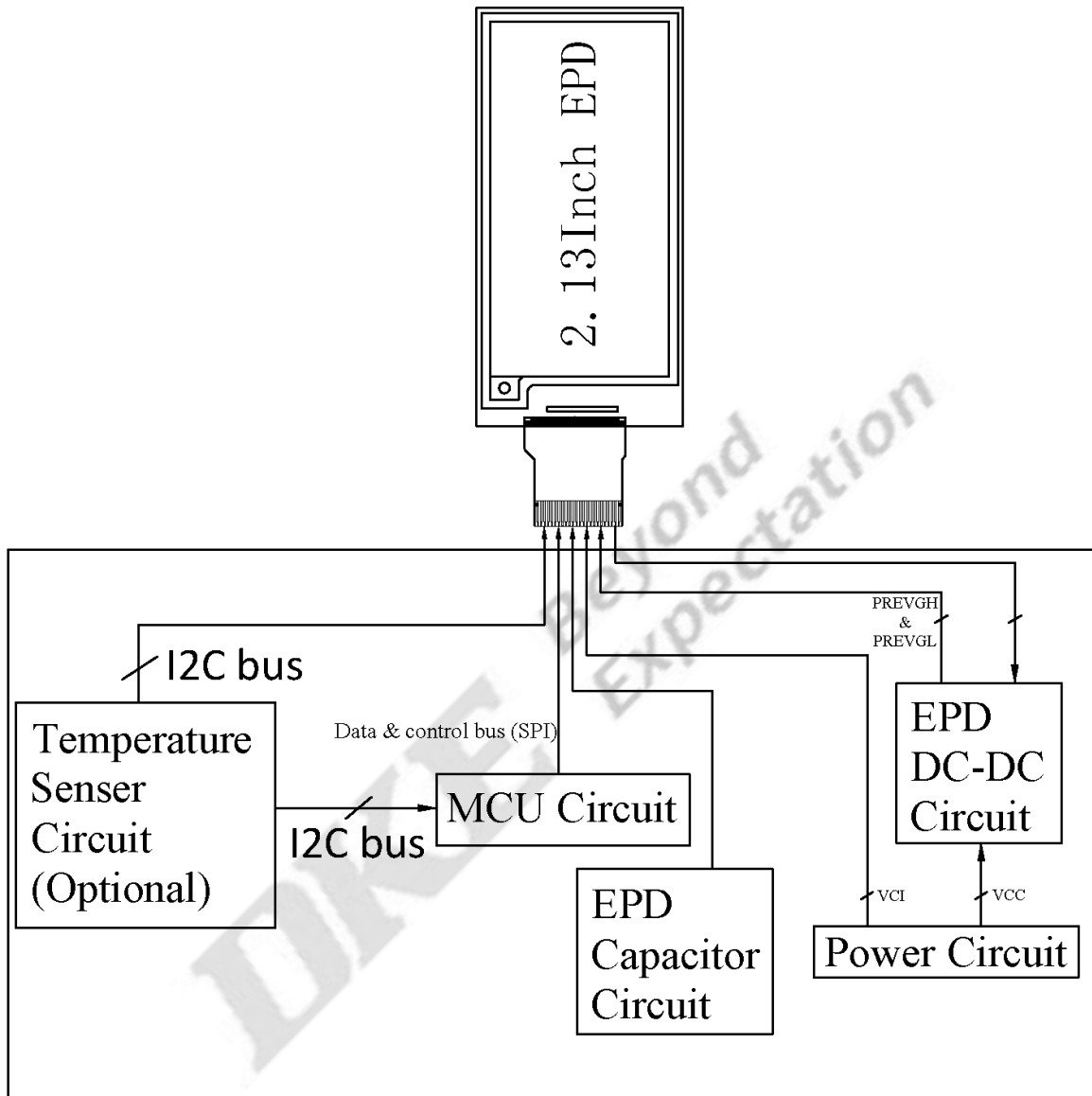

9. Typical Application Circuit with SPI Interface

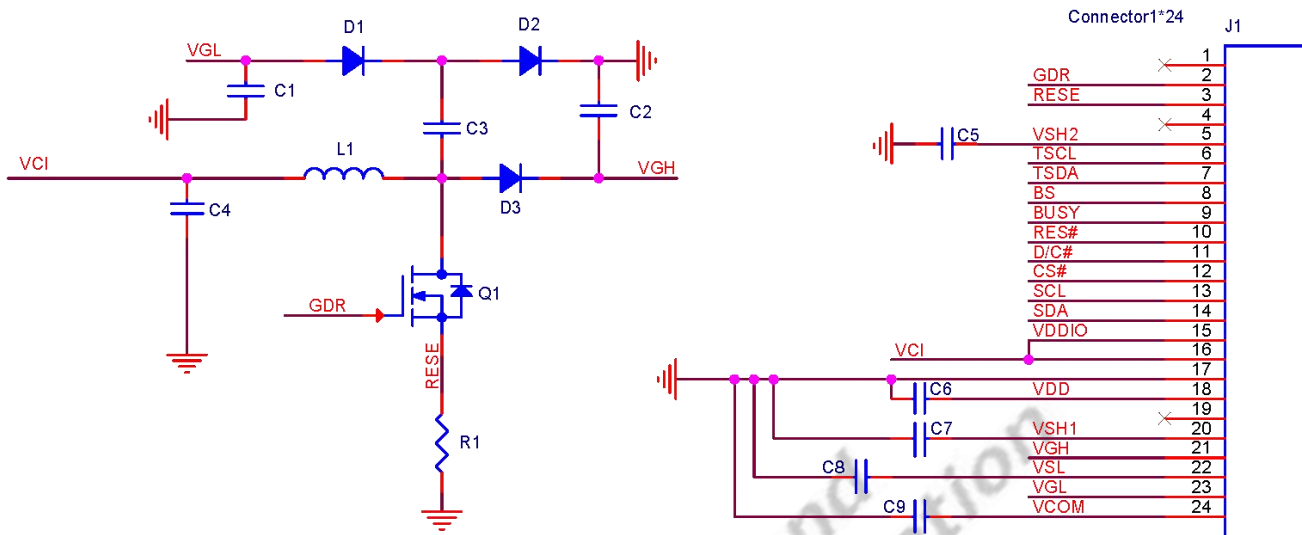

Part Name	Value	Reference Part	Requirements for spare part
C4 C6	1uF	X5R/X7R; Voltage Rating: 6v or 25v	
C1 C2 C3 C5 C7 C8	1uF	0402/0603/0805; X5R/X7R; Voltage Rating: 25v	
C9	0.47uF/1uF	0603/0805; X7R; Voltage Rating: 25v NOTE: Effective capacitance >0.25uF @18v DC bias	
R1	2.2Ohm	0402/0603/0805; 1% variation, ≥0.05W	
D1 D2 D3	Diode	MBR0530	1) Reverse DC Voltage ≥30V 2) Io ≥500mA 3) Forward voltage ≤430mV
Q1	NMOS	Si1304BDL/NX3008NBK	1) Drain-Source breakdown voltage ≥30v 2) Vgs(th)=0.9v(Typ), 1.3v(Max) 3) rds on ≤2.1Ω @ Vgs=2.5v
L1	47UH	CDRH2D18/LDNP-470NC	1) Io=500mA(max)

10. Typical Operating Sequence

10.1 OTP Operation Flow

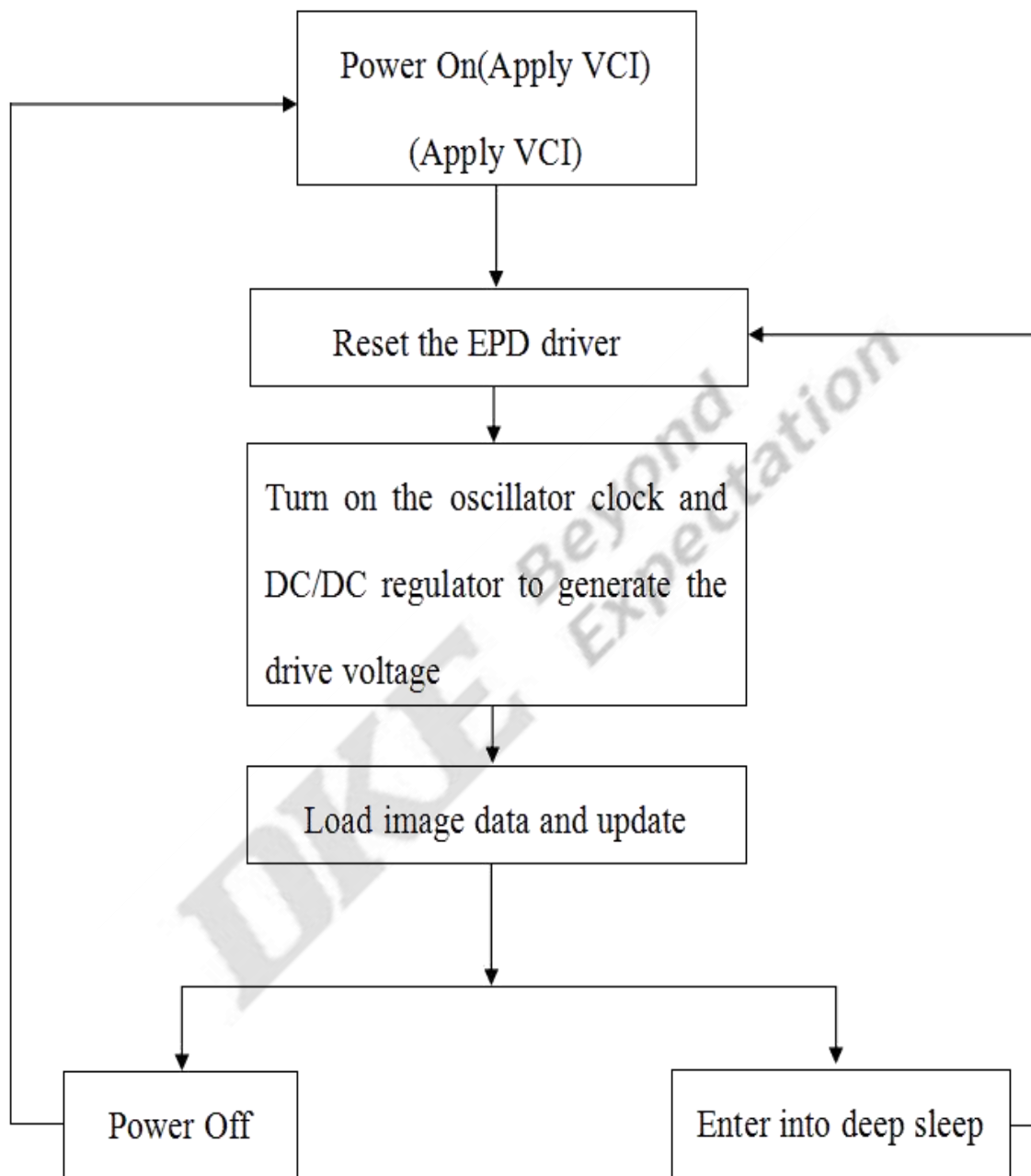

10.2 OTP Operation Reference Program Code

ACTION	VALUE/DATA	COMMENT
POWER ON		
delay	10ms	
PIN CONFIG		
RESE#	low	Hardware reset
delay	200us	
RESE#	high	
delay	200us	
Read busy pin		Wait for busy low
Command 0x12		Software reset
Read busy pin		Wait for busy low
SET VOLTAGE AND LOAD LUT		
LOAD IMAGE AND UPDATE		
Command 0x24	4000bytes	Load image (122/8*250)(BW)
Command 0x20		
Read busy pin		Wait for busy low
Command 0x10	Data 0X01	Enter deep sleep mode
POWER OFF		

11. Reliability Test

NO	Test items	Test condition
1	Low-Temperature Storage	T = -25°C, 240 h Test in white pattern
2	High-Temperature Storage	T=+70°C, RH=40%, 240h Test in white pattern
3	High-Temperature Operation	T=+50°C, RH=30%, 240h
4	Low-Temperature Operation	0°C, 240h
5	High-Temperature, High-Humidity Operation	T=40°C, RH=90%, 240h
6	High Temperature, High Humidity Storage	T=60°C, RH=80%, 240h Test in white pattern
7	Temperature Cycle	1 cycle:[-25°C 30min]→[+70 °C 30 min] : 100 cycles Test in white pattern
8	ESD Gun	Air+/-4KV;Contact+/-2KV Contact+/-2KV(HBMC:100pF;R:1.5k ohm) Contact+/-200V(MMC:200pF;R:0 ohm) (Naked EPD display,including IC and FPC area)
9	UV exposure Resistance	765W/m ² for 168hrs,40 °C Test in white pattern

Note: 1. Stay white pattern for storage and non-operation test.
2. Operation is black→white pattern, the interval is 150s.

12. Quality Assurance

12.1 Environment

Temperature: 23±3°C
 Humidity: 55±10%RH

12.2 Illuminance

Brightness: 1200~1500LUX; distance: 20-30CM; Angle: Relate 45° surround.

12.3 Inspect method

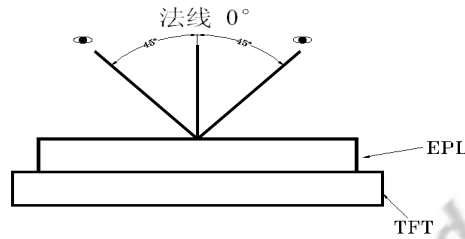

12.4 Display area

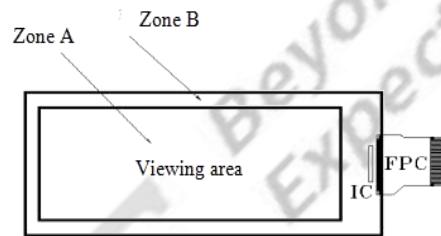

12.5 Ghosting test method

Two-color ghosting is measured with following transition from horizontal 2 scale pattern to vertical 2 scale pattern. The listed optical characteristics are only guaranteed under the controller & waveform provided by DKE.

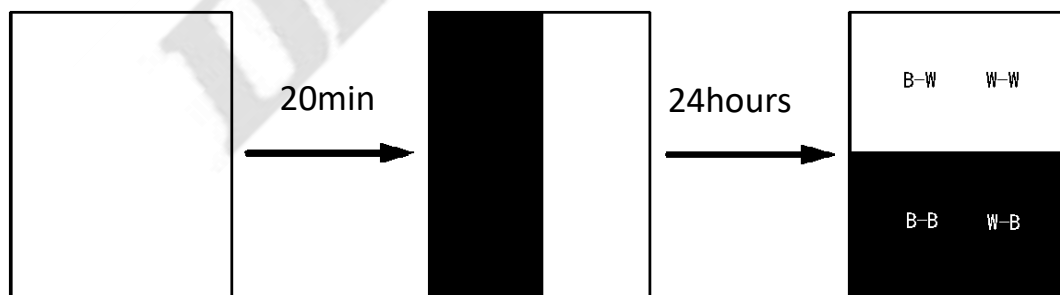

1) Measurement Instruments: X-rite i1Pro

2) Ghosting formula:

W ghosting: $\Delta L = \text{Max} (\Delta L(W-W, B-W)) - \text{Min} (\Delta L(W-W, B-W))$



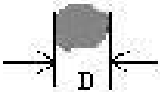
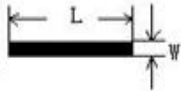

K ghosting: $\Delta L = \text{Max} (\Delta L(W-B, B-B)) - \text{Min} (\Delta L(W-B, B-B))$

12.6 Inspection standard

12.6.1 Electric inspection standard

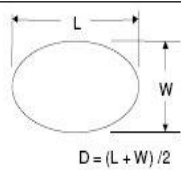
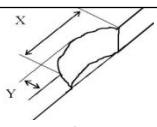
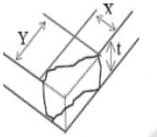
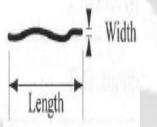
NO.	Item	Standard	Defect level	Method	Scope
1	Display	Display complete Display uniform	MA	Visual inspection	
2	Black/White spots	 <p>$D \leq 0.25\text{mm}$, Allowed $0.25\text{mm} < D \leq 0.4\text{mm}$. $N \leq 4$ allowable $D > 0.4\text{mm}$ is not allowed</p>	MI		
3	Show B/W lines	 <p>$L \leq 0.4\text{mm}, W \leq 0.1\text{mm}$ negligible $0.4\text{mm} < L \leq 1.0\text{mm}$ $0.1\text{mm} < W \leq 0.4\text{mm}$ $N \leq 4$ allowable $L > 1.0\text{mm}, W > 0.4\text{mm}$ is not allowed</p>		Visual/ Inspection card	Zone A
4	Ghost image	Allowed in switching process	MI	Visual inspection	
5	Flash dot / Multilateral	Flash points are allowed when switching screens Multilateral colors outside the frame are allowed for fixed screen time	MI	Visual/ Inspection card	Zone A Zone B
6	Segmented display	Selection segments are all displayed, and other segments are not displayed after the selection segment.	MA	Visual inspection	Zone A
7	Short circuit/ Circuit break/ Display abnormal	Not Allow			

12.6.2 Appearance inspection standard

NO.	Item	Standard	Defect level	Method	Scope
1	B/W spots /Bubble/ Foreign bodies/ Dents	 <p>$D = (L + W) / 2$</p> <p>$D \leq 0.25\text{mm}$ negligible $0.25\text{mm} < D \leq 0.4\text{mm}$ $N \leq 4$ allowable $D > 0.4\text{mm}$ is not allowed</p>	MI	Visual inspection	Zone A
2	Glass crack	Not Allow	MA	Visual / Microscope	Zone A Zone B
3	Dirty	Allowed if can be removed	MI		Zone A Zone B
4	Chips/Scratch/ Edge crown	 <p>$X \leq 3\text{mm}, Y \leq 0.5\text{mm}$ And without affecting the electrode is permissible</p>  <p>$2\text{mm} \leq X$ or $2\text{mm} \leq Y$ Not Allow</p>  <p>$W \leq 0.1\text{mm}, L \leq 5\text{mm}$, No harm to the electrodes and $N \leq 2$ allow</p>	MI	Visual / Microscope	Zone A Zone B
5	TFT Cracks	 <p>Not Allow</p>	MA	Visual / Microscope	Zone A Zone B
6	Dirty/ foreign body	Allowed if can be removed/ allow	MI	Visual / Microscope	Zone A / Zone B
7	FPC broken/ Goldfingers oxidation/ scratch	  <p>Not Allow</p>	MA	Visual / Microscope	Zone B

8	B/W Line	 <p> $L \leq 1.0\text{mm}, W \leq 0.15\text{mm}$ negligible $1.0\text{mm} < L \leq 4.0\text{mm}$ $0.15\text{mm} < W \leq 0.5\text{mm}$ $N \leq 4$ allowable $L > 4.0\text{mm}, W > 0.5\text{mm}$ is not allowed </p>	MI	Visual / Ruler	Zone B
9	TFT edge bulge /TFT chromatic aberration	<p>TFT edge bulge: $X \leq 3\text{mm}, Y \leq 0.3\text{mm}$ Allowed TFT chromatic aberration :Allowed</p>	MI	Visual / Microscope	Zone A Zone B
10	Electrostatic point	<p> $D \leq 0.25\text{mm}$, allow $0.25\text{mm} < D \leq 0.4\text{mm}, n \leq 4$ allow $D > 0.4\text{mm}$ is not allowed ($n \leq 8$ items are allowed within 5 mm in diameter) </p>	MI	Visual / Microscope	Zone A
11	PCB damaged/ Poor welding/ Curl	<p>PCB (Circuit area) damaged Not Allow PCB Poor welding Not Allow PCB Curl $\leq 1\%$</p>			
12	Edge glue height/ Edge glue bubble	<p>Edge Adhesives $H \leq \text{PS surface}$ (Including protect film) Edge adhesives seep in $\leq 1/2$ Margin width Length excluding Edge adhesives bubble: bubble Width $\leq 1/2$ Margin width; Length $\leq 0.5\text{mm}$. $n \leq 5$</p>	MI	Visual / Ruler	Zone B
13	Protect film	Surface scratch but not effect protect function, Allowed		Visual Inspection	
14	Silicon glue	<p>Thickness $\leq \text{PS surface}$(With protect film): Full cover the IC; Shape: The width on the FPC $\leq 0.5\text{mm}$ (Front) The width on the FPC $\leq 1.0\text{mm}$ (Back) smooth surface, No obvious raised.</p>	MI	Visual Inspection	
15	Warp degree (TFT substrate)	 <p> $t \leq 1.0\text{mm}$ </p>	MI	Ruler	
16	Color difference in COM area (Silver point area)	Allowed		Visual Inspection	

13.Packaging

EPD PACKING INSTRUCTION					DATE	
DKE-QS. D-010					DESIGN	
					CHECKED	
					APPROVED	

P/N	Customer Code	Ref. P/N	Type	PKG Method	Marking	Surface Marks	Pull Tape
DEPG0213			GLASS	Blister	BACK	None	YES

Packing Materials List					28PCS/LAYER, 20LAYER/CTN, TOTAL 560PCS/CTN.	
List	Model	Materials	Q'ty	Unit	Pull tape:	
Carton	7# 417*362*229 mm	corrugate	1	Piece		
Inner Carton	7# (INNER) 400*343 *95 mm	corrugate	2	Piece		
Blister	DEPG0213C2	PET	22	Piece		
Thin foam	DEPG0213C2 291, 308*265, 308*11, 5-1.5mm	EPE	20	Piece		
Antistatic vacuum bag	450*590*0.075		2	Piece		
Foam board	DKE2251-10	EPE	3	Piece		
PULL TAPE	16*5*T0.05		560	Piece		

Detail:

Blister box:

Note: there are 20 layers of products, divided into 2 inner boxes, and an empty blister box is placed on the top of each inner box, so the number of blister boxes is 22

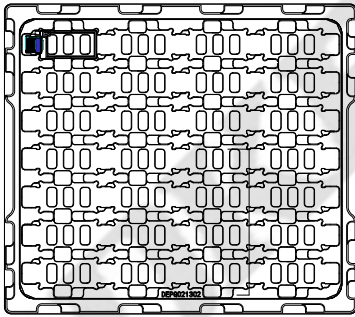

QUANTITY: 28PCS

The blister box is rotated for placement

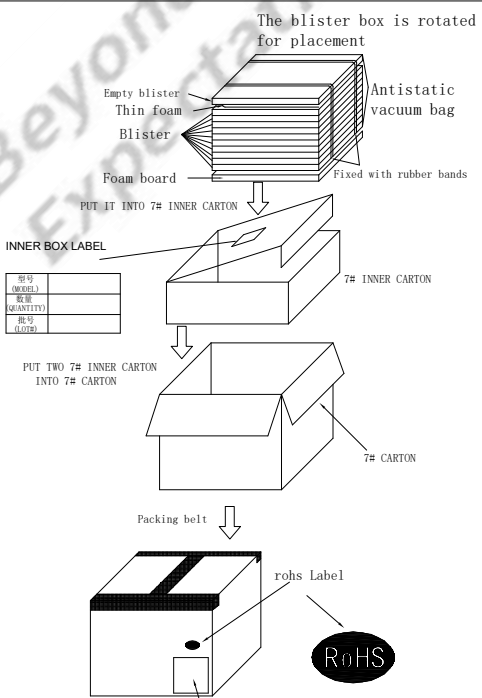

INNER BOX LABEL

#P/N (MODEL)	
R# (QUANTITY)	
#L# (LAYER)	

PUT TWO 7# INNER CARTON INTO 7# CARTON

Packing belt

rohs Label



Shipping marks according to customer's requirements

Epaper Identification	
QC:	PASS
Model No.:	
Quantity:	_____ pcs
Date:	
Carton No.:	_____ of _____

14. Handling, Safety, and Environment Requirements

Warning

The display glass may break when it is dropped or bumped on a hard surface. Handle with care. Should the display break, do not touch the electrophoretic material. In case of contact with electrophoretic material, wash with water and soap.

Caution

The display module should not be exposed to harmful gases, such as acid and alkali gases, which corrode electronic components. Disassembling the display module.

Disassembling the display module can cause permanent damage and invalidates the warranty agreements.

Observe general precautions that are common to handling delicate electronic components. The glass can break and front surfaces can easily be damaged. Moreover the display is sensitive to static electricity and other rough environmental conditions.

Data sheet status	
Product specification	This data sheet contains final product specifications.
Limiting values	
Limiting values given are in accordance with the Absolute Maximum Rating System (IEC 134). Stress above one or more of the limiting values may cause permanent damage to the device. These are stress ratings only and operation of the device at these or at any other conditions above those given in the Characteristics sections of the specification is not implied. Exposure to limiting values for extended periods may affect device reliability.	
Application information	
Where application information is given, it is advisory and does not form part of the specification.	
Product Environmental certification	
ROHS	
REMARK	
All The specifications listed in this document are guaranteed for module only. Post-assembled operation or component(s) may impact module performance or cause unexpected effect or damage and therefore listed specifications is not warranted after any Post-assembled operation.	
Transport environment	
When the humidity of transportation environment is between 45%RH~70%RH, the product can be stored for 30 days, and the product can be stored for 10 days if it is lower or higher than this range	